



50Ω TERMINATED 18 GHz SMA LATCHING D.P.3.T. SWITCH

OPTIONS :/SUPP.DIODES

R F CHARACTERISTICS

FREQUENCY RANGE : 0 - 18 GHz
 IMPEDANCE : 50 Ohms

FREQUENCY (GHz)	0 - 3	3 - 8	8 -12.4	12.4- 18
V.S.W.R <=	1.20	1.30	1.40	1.50
INSERT. LOSS <=	0.20 dB	0.30 dB	0.40 dB	0.50 dB
ISOLATION >=	80 dB	70 dB	60 dB	60 dB
AVER. POWER (*)	240 W	150 W	120 W	100 W

ELECTRICAL CHARACTERISTICS

ACTUATOR : LATCHING
 NOMINAL CURRENT AT 25° C (±10%) : 160 mA
 ACTUATOR VOLTAGE (Vcc) : 28V (24 to 30V) / POSITIVE COMMON
 TERMINALS : solder pins (250° C max./30 sec.)

MECHANICAL CHARACTERISTICS

CONNECTORS : SMA female per MIL C 39012
 LIFE : 10.000.000 cycles
 SWITCHING TIME (nominal voltage;25° C) : < 10 ms
 CONSTRUCTION : splashproof
 WEIGHT : < 100 g

ENVIRONMENTAL CHARACTERISTICS

OPERATING TEMPERATURE RANGE (°C) : -40 , +85
 STORAGE TEMPERATURE RANGE (°C) : -55 , +85

(* : average power at 25° C)

This information is given as an indication. In the continual goal to improve our products, we reserve the right to make any modifications judged necessary

4112-9212

DRAWING

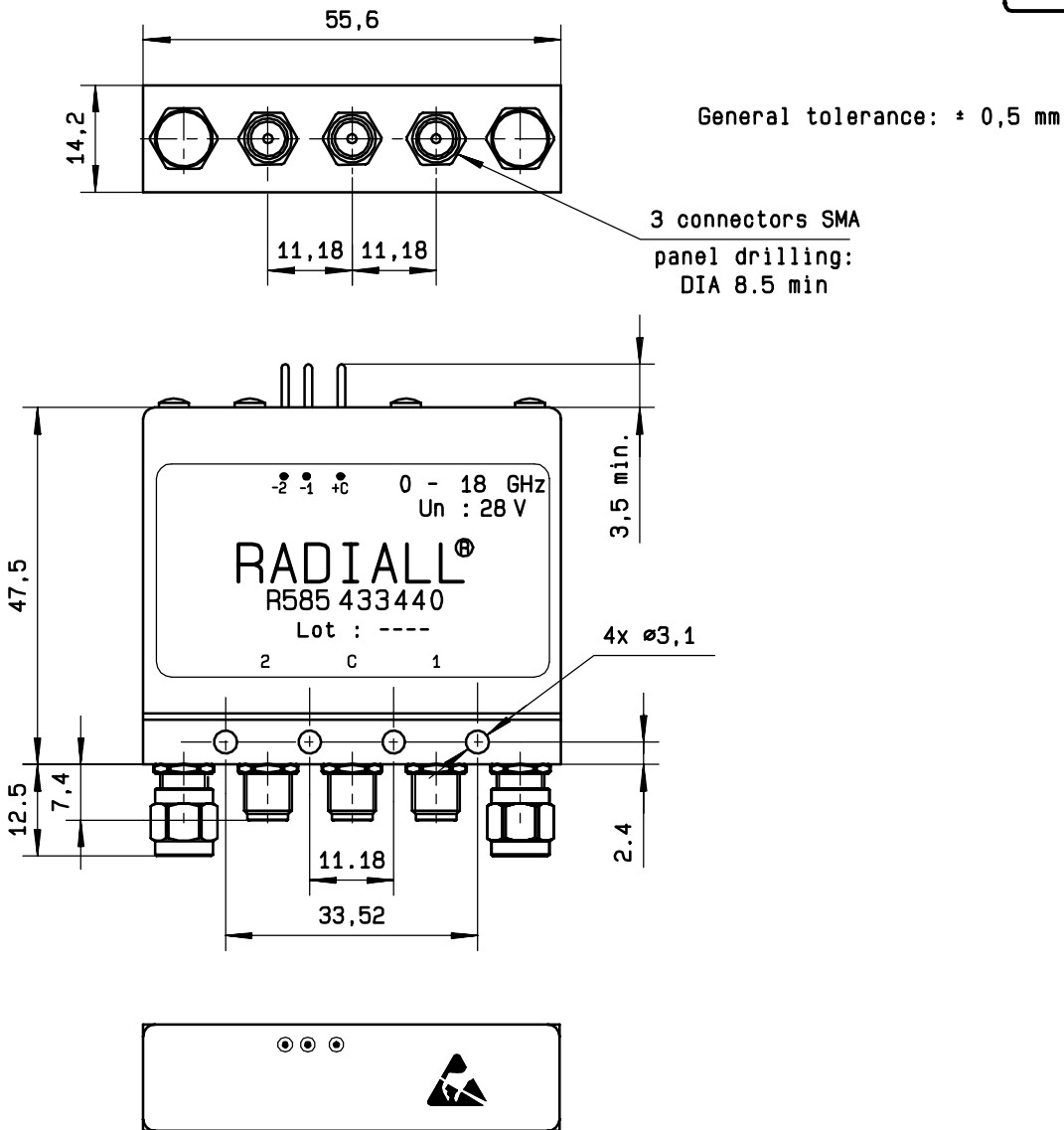

SCHEMATIC DIAGRAM

Voltage	RF continuity
+ C - 1	C ↔ 1 / 2 ↔ 50Ω
+ C - 2	C ↔ 2 / 1 ↔ 50Ω

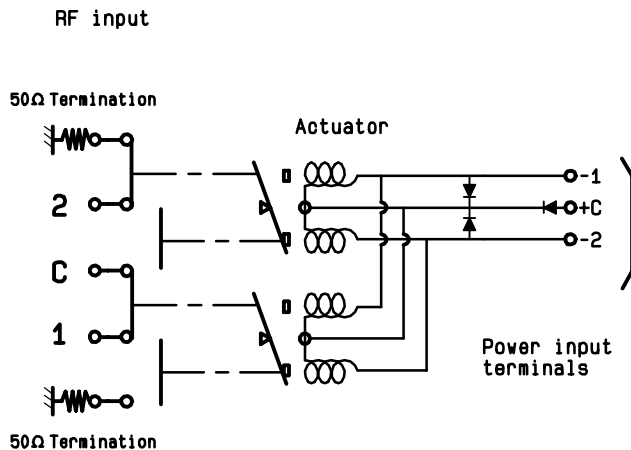

4113-9212 This information is given as an indication. In the continual goal to improve our products, we reserve the right to make any modifications judged necessary